

# 36W DALI DT8 NFC Enabled Round LED Driver(Constant Current)

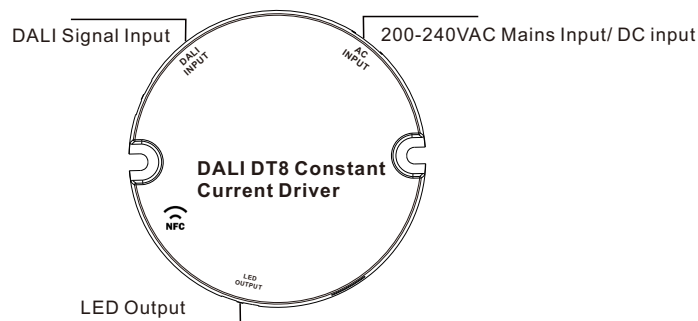

**Important:** Read All Instructions Prior to Installation

## Function introduction



## Product Data

Output	LED Channel	2
	DC Voltage	20-42V
	Current	600-1200mA via NFC tool; Min.current gear lower to 0.1mA, default 900mA
	Current Accuracy	±3% (±1% @ Certain full load) @ full load
	Rated Power	Max. 36W
Input	Voltage Range	200-240VAC/200-240VDC
	Absolute Voltage Range	176-264VAC/176-280VDC
	Frequency Range	0/50/60Hz
	Power Factor (Typ.)	> 0.98 @ 230VAC Full load
	Total Harmonic Distortion	THD ≤ 7% (@ full load / 230VAC)
	Efficiency (Typ.)	> 86% @ 230VAC full load
	AC Current (Typ.)	0.3A @ 230VAC
	Inrush Current (Typ.)	Max. 10.46A at 230VAC; 189µs duration
	Leakage Current	< 5mA /230VAC
	Standby Power Consumption	< 0.5W
Control	Anti Surge	L-N:2KV
	Dimming Interface	DALI Device Type 8 (DALI consumption < 2mA)/ AC Push
	Dimming Range	0.01%-100% @ Max current
	Dimming Method	Amplitude/CCR dimming
	Dimming Curve	Linear/ Logarithmic optional

Protection	Short Circuit	Yes, recovers automatically after fault condition is removed
	Over Current	Yes, recovers automatically after fault condition is removed
	Over Temperature	Yes, recovers automatically after temperature drop
Environment	Working Temp.	-25°C ~ +60°C
	Max. Case Temp.	Tc=85°C
	Working Humidity	10% ~ 95% RH non-condensing
	Storage Temp. & Humidity	-40°C ~ +80°C, 10% ~ 95% RH
Safety & EMC	Safety Standards	EN61347-1, EN61347-2-13
	Withstand Voltage	I/P-O/P: 3.75KVAC
	Isolation Resistance	I/P-O/P: 100M Ohms / 500VDC / 25°C / 70% RH
	EMC Emission	En55015, EN61000-3-2, EN61000-3-3
	EMC Immunity	En61547, EN61000-4-2,3,4,5,6,8,11
Others	MTBF	191350H, MIL-HDBK-217F @ 230VAC full load and 25°C ambient temperature
	Dimension	φ72x30mm (D*H)
	Warranty	5 Years

- In compliance with IEC 62386-101:2014, IEC 62386-102:2014, IEC 62386-207 Ed2, IEC 62386-209
- Built-in DALI-2 interface, DALI DT8 device
- Dimmable LED driver. Max. output power 36W
- 600-1200mA current selectable via NFC program tool. Min.current gear lower to 0.1mA
- DALI Address/Group/Scene setting via NFC program tool.
- Class II power supply, full isolated plastic case
- High power factor and efficiency
- ON/OFF, Dimming and Tunable White control
- Amplitude/CCR dimming, smooth and deep dimming
- Compatible with universal DALI masters that support DT8 commands
- CLO function for a further upgraded experience
- IP20 rating, suitable for indoor LED lighting applications
- 5 years warranty

## Safety & Warnings

- DO NOT install with power applied to the device.
- DO NOT expose the device to moisture.

## Operation

With DALI master

### 1. DALI Address

1 DALI address for 2 channels output are assigned by DALI Master controller automatically, please refer to user manuals of compatible DALI Masters for specific operations.

With NFC Programming devices

**Note**

1) Do wiring according to the wiring diagram and power on the DALI system .

2) Recommend setting parameters without power-on the DALI devices .

2) Please make sure your mobile phone has NFC function and enable it .

**Working with “SR NFC Tool” APP**

**Step 1: Download the APP (searching “SR NFC Tool” from App Store and Google Play) . Then open the APP .**

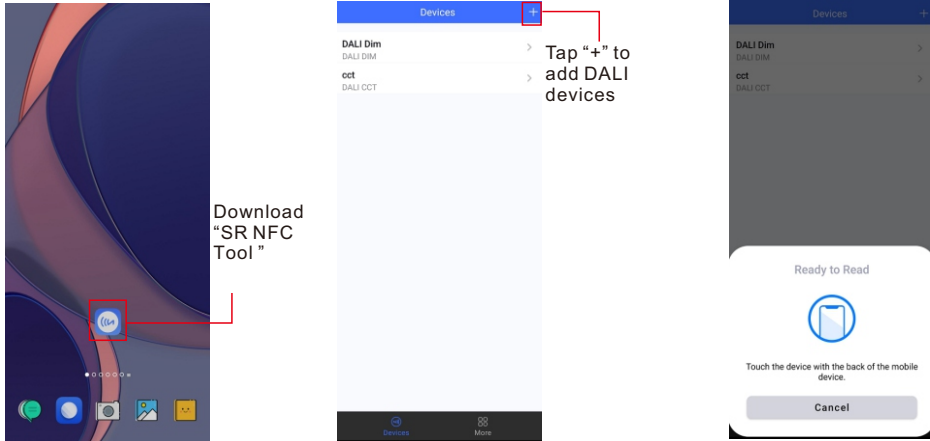

- Note:**
1. Please Make sure that you have enabled NFC function with your mobile phone/ tablet .
  2. Please Make sure that the “NFC position” is matched.
  3. Please do not power on the device before setting.
  4. If you can't download “SR NFC Tool”. Please contact with us.

**Step 2: Add device, and name it as you wish.**

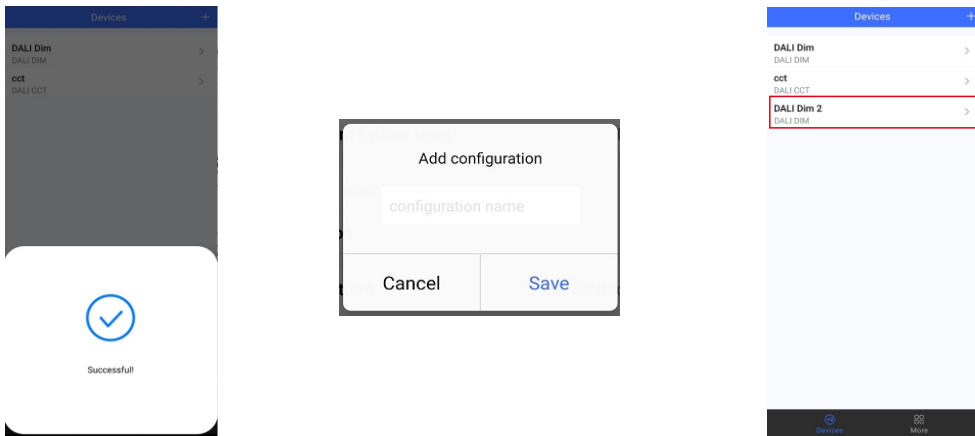

**Step 3: Unlock device, enter parameters configuring page.**



- Note:**
1. You have to unlock the device then do some settings
  2. Only when the corresponding function is selected, the function interface will be displayed.

**Step 4: Few parameter interface, you can choose the setting based on your requirements.**



**Step 5: After setting, please save the selected configuration via NFC and power on the device.**

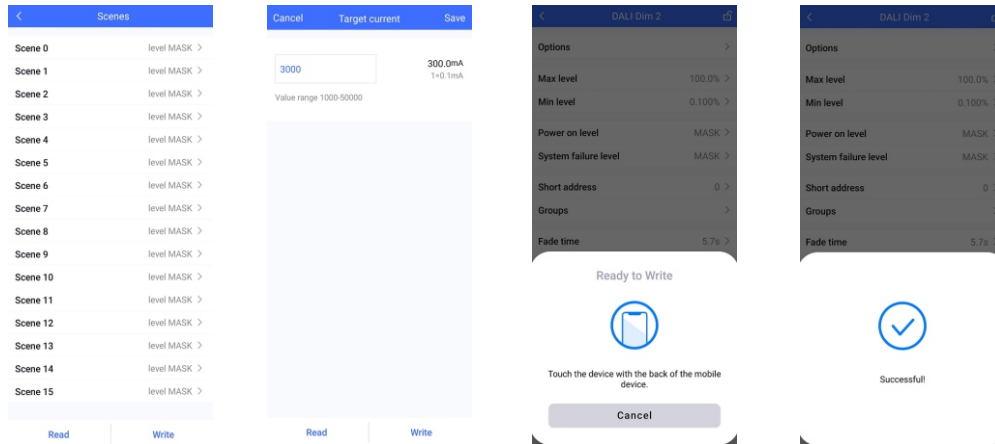

## Tips

1. NFC function doesn't require any power driver.
2. Many functions can be configured by NFC. Kindly check your desired functions.
3. All of our DALI drivers are in the best performance within our DALI master/ DALI IoT gateway.

## Wiring Diagram

1. With DALI bus

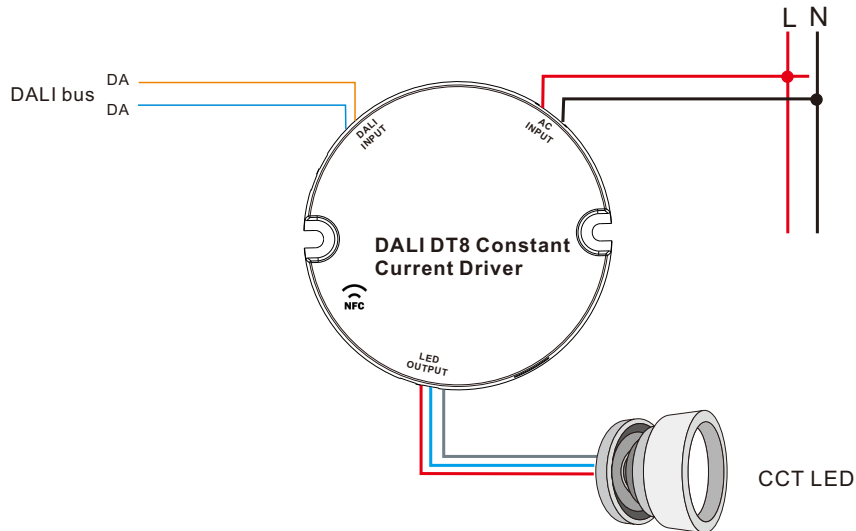

2. With PUSH dimmer

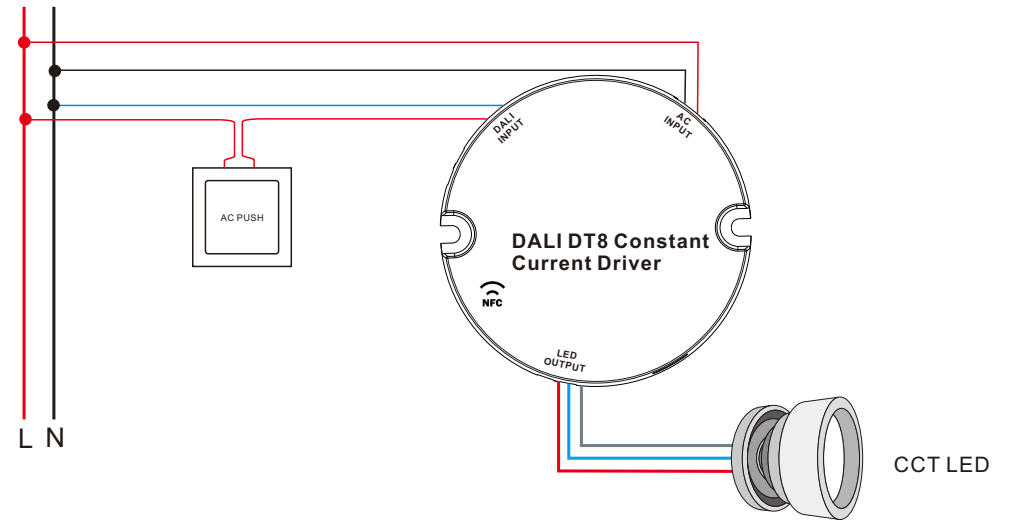

## AC Push Function

- 1) Click the button to switch ON/OFF
- 2) Press and hold down the button to increase or decrease light intensity to desired level and release it, then repeat the operation to adjust light intensity to opposite direction. The dimming range is from 1% to 100%.

## Product Dimension

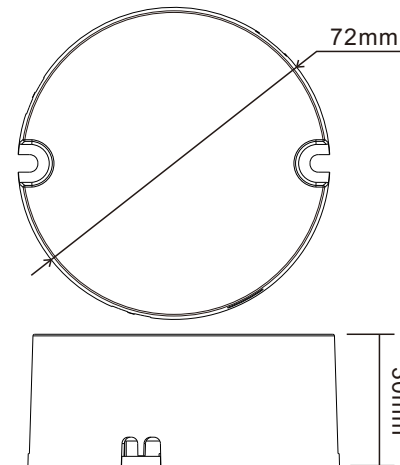

## Update log

Date	Version	Update content	Update by
2023-5-13	V1.0	Initial Version	Romeo

Note: Subject to change without notice. Please contact us if you have any questions.